

Unter Haßlen 20 · D-78532 Tuttlingen
Phone: +49 (0)7462/9470-0
Fax: +49 (0)7462/9470-50
e-mail: sales@rz-medizintechnik.com
<http://www.rz-medizintechnik.com>



RZ Medizintechnik
GmbH *Progress in Surgery*

The RZ BULLDOG CLAMPS Family



Titanium Bulldog Clamps (Mini Glover)

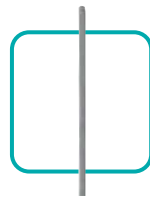

straight

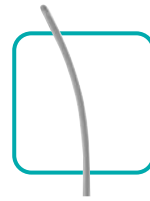

slightly curved



strongly curved

Mini Glover

Material: Titanium

Very delicate serrations



Article-No.		Total length		Jaw length
140-116-030	straight	30mm	V	9mm
140-116-130	straight	30mm	A	9mm
140-116-035	straight	35mm	V	13mm
140-116-135	straight	35mm	A	13mm
140-116-040	straight	40mm	V	14mm
140-116-140	straight	40mm	A	14mm
140-116-050	straight	50mm	V	23mm
140-116-150	straight	50mm	A	23mm
140-117-030	slightly curved	30mm	V	9mm
140-117-130	slightly curved	30mm	A	9mm
140-117-035	slightly curved	35mm	V	13mm
140-117-135	slightly curved	35mm	A	13mm
140-117-040	slightly curved	40mm	V	14mm
140-117-140	slightly curved	40mm	A	14mm
140-117-050	slightly curved	50mm	V	23mm
140-117-150	slightly curved	50mm	A	23mm
140-118-030	strongly curved	30mm	V	9mm
140-118-130	strongly curved	30mm	A	9mm
140-118-035	strongly curved	35mm	V	13mm
140-118-135	strongly curved	35mm	A	13mm
140-118-040	strongly curved	40mm	V	14mm
140-118-140	strongly curved	40mm	A	14mm
140-118-050	strongly curved	50mm	V	23mm
140-118-150	strongly curved	50mm	A	23mm

Closing pressure

V=Vein: 110g (+/- 10gr.)

A=Artery: 220g (+/- 10gr.)

Suitable
Applying
Forceps on
page 14

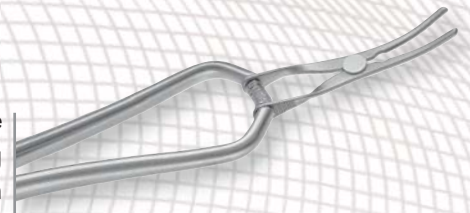

TITANIUM

Stainless Steel Bulldog Clamps (Mini Glover)

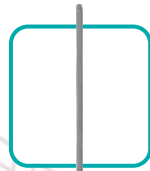
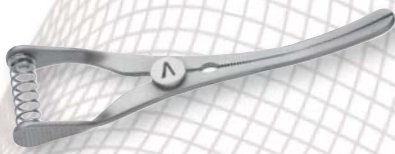

straight



slightly curved



strongly curved

Mini Glover

Material: Stainless steel
Very delicate serrations



Article-No.		Total length		Jaw length
140-130-030	straight	30mm	V	9mm
140-130-130	straight	30mm	A	9mm
140-130-035	straight	35mm	V	13mm
140-130-135	straight	35mm	A	13mm
140-130-040	straight	40mm	V	14mm
140-130-140	straight	40mm	A	14mm
140-130-050	straight	50mm	V	23mm
140-130-150	straight	50mm	A	23mm
140-131-030	slightly curved	30mm	V	9mm
140-131-130	slightly curved	30mm	A	9mm
140-131-035	slightly curved	35mm	V	13mm
140-131-135	slightly curved	35mm	A	13mm
140-131-040	slightly curved	40mm	V	14mm
140-131-140	slightly curved	40mm	A	14mm
140-131-050	slightly curved	50mm	V	23mm
140-131-150	slightly curved	50mm	A	23mm
140-132-030	strongly curved	30mm	V	9mm
140-132-130	strongly curved	30mm	A	9mm
140-132-035	strongly curved	35mm	V	13mm
140-132-135	strongly curved	35mm	A	13mm
140-132-040	strongly curved	40mm	V	14mm
140-132-140	strongly curved	40mm	A	14mm
140-132-050	strongly curved	50mm	V	23mm
140-132-150	strongly curved	50mm	A	23mm

Closing pressure

V=Vein: 110g (+/- 10gr.)
A=Artery: 220g (+/- 10gr.)

Suitable
Applying
Forceps on
page 14



STAINLESS STEEL

Atrauma De Bakey Bulldog Clamps



DeBakey

Material: Stainless steel

Delicate atraumatic serrations



140-120-075	straight	75mm
140-120-085	straight	85mm
140-120-105	straight	100mm
140-120-120	straight	120mm
140-119-075	curved	75mm
140-119-085	curved	85mm
140-119-105	curved	100mm
140-119-120	curved	120mm



straight



curved

Cooley

Material: Stainless steel

Cooley serrations



290-440-075	straight	75mm
290-440-085	straight	85mm
290-440-100	straight	100mm
290-440-120	straight	120mm
290-441-075	curved	75mm
290-441-085	curved	85mm
290-441-100	curved	100mm
290-441-120	curved	120mm

Suitable Applying
Forceps on page 15

Diethrich Micro Coronary Bulldog Clamps



De Bakey Diethrich

Material: Stainless steel

Extra delicate atraumatic serrations



Closing pressure:
180gr. (+/- 10gr.)

Article-No.		Jaw length	Total length
290-120-010	straight	10mm	45mm
290-120-014	straight	14mm	50mm
290-120-020	straight	20mm	60mm
290-121-010	angled	10mm	35mm
290-121-014	angled	14mm	45mm
290-121-020	angled	20mm	60mm
290-122-010	curved	10mm	45mm
290-122-014	curved	14mm	50mm
290-122-020	curved	20mm	60mm



straight



angled



curved

Diethrich

Material: Stainless steel

Extra delicate serrations



Closing pressure:
50gr. (+/- 10gr.)

Article-No.		Jaw length	Total length
140-125-080	straight	8mm	45mm
140-125-120	straight	12mm	50mm
140-125-200	straight	20mm	60mm
140-121-080	angled	8mm	35mm
140-121-120	angled	12mm	45mm
140-121-200	angled	20mm	60mm
140-122-080	curved	8mm	45mm
140-122-120	curved	12mm	50mm
140-122-200	curved	20mm	60mm

Diethrich Micro Coronary Clamps



straight



angled



curved

Diethrich

Material: Stainless steel

Without any serrations, smooth jaws



Article-No.		Jaw length	Total length
140-008-045	straight	8mm	45mm
140-012-050	straight	12mm	50mm
140-020-060	straight	20mm	60mm
140-108-045	angled	8mm	35mm
140-112-050	angled	12mm	45mm
140-120-060	angled	20mm	60mm
140-208-045	curved	8mm	45mm
140-212-050	curved	12mm	50mm
140-220-060	curved	20mm	60mm

Weldon Bulldog Clamps



straight



slightly curved

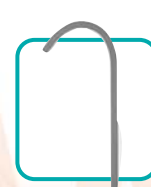

strongly curved

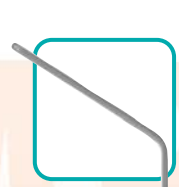

angled

Weldon

Material: Stainless steel

Very delicate serrations



140-013-035	straight	35mm
140-022-045	straight	45mm
140-015-035	slightly curved	35mm
140-023-045	slightly curved	45mm
140-016-035	strongly curved	35mm
140-024-045	strongly curved	45mm
140-017-035	angled	35mm
140-025-045	angled	45mm

Johns-Hopkins Bulldog Clamps



straight



curved

Johns-Hopkins
Material: Stainless steel
Extra delicate serrations



140-050-038	straight	38mm
140-050-050	straight	48mm
140-050-057	straight	56mm
140-050-063	straight	63mm
140-050-070	straight	70mm
140-050-076	straight	80mm
140-050-090	straight	90mm
140-051-038	curved	38mm
140-051-050	curved	48mm
140-051-057	curved	56mm
140-051-063	curved	63mm
140-051-070	curved	70mm
140-051-076	curved	80mm
140-051-090	curved	90mm

Suitable
Applying
Forceps on
page 14



Dieffenbach Bulldog Clamps



straight



curved

Dieffenbach
Material: Stainless steel
Extra delicate serrations



140-114-035	straight	35mm
140-114-040	straight	40mm
140-114-050	straight	50mm
140-110-060	straight	60mm

140-115-035	curved	35mm
140-115-050	curved	40mm
140-115-055	curved	50mm
140-115-060	curved	60mm

Glover Bulldog Clamps

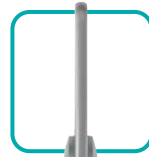

straight



angled



curved

De Bakey Glover

Material: Stainless steel

Delicate atraumatic serrations

Closing pressure adjustable



Cooley Glover

Material: Stainless steel

Cooley serrations

Closing pressure adjustable



Article-No.		Total length	Jaw length
140-132-060	angled	55mm	27mm
140-130-060	straight	60mm	20mm
140-130-070	straight	75mm	30mm
140-130-090	straight	90mm	43mm
140-130-110	straight	110mm	56mm
140-131-060	curved	60mm	20mm
140-131-070	curved	75mm	30mm
140-131-090	curved	90mm	43mm
140-131-110	curved	110mm	56mm

Article-No.		Total length	Jaw length
290-432-060	straight	60mm	20mm
290-432-075	straight	75mm	30mm
290-432-090	straight	90mm	43mm
290-432-110	straight	110mm	56mm
290-433-060	curved	60mm	20mm
290-433-075	curved	75mm	30mm
290-433-090	curved	90mm	43mm
290-433-110	curved	110mm	56mm

Glover Satinsky Bulldog Clamps



De Bakey Glover Satinsky

Material: Stainless steel

Delicate atraumatic serrations

Closing pressure adjustable



double
angulation

Article-No.		Total length	Jaw length
140-133-060	double angulation	70mm	38mm
140-133-100	double angulation	100mm	63mm

Hess Bulldog clamps



angled

Hess

Material: Stainless steel

Delicate serrations



140-056-020	angled	20mm jaw
140-056-030	angled	30mm jaw

Softgrip Titanium Bulldog clamps

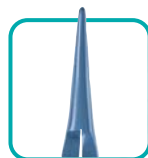

straight



angled



curved

Softgrip Titanium

Material: Titanium

Extra delicate serrations

Featherlight



140-750-008	straight	8mm jaw
140-750-012	straight	12mm jaw
140-750-020	straight	20mm jaw
140-751-008	angled	8mm jaw
140-751-012	angled	12mm jaw
140-751-020	angled	20mm jaw
140-752-008	curved	8mm jaw
140-752-012	curved	12mm jaw
140-752-020	curved	20mm jaw

TITANIUM

Gregory Soft Bulldog clamps

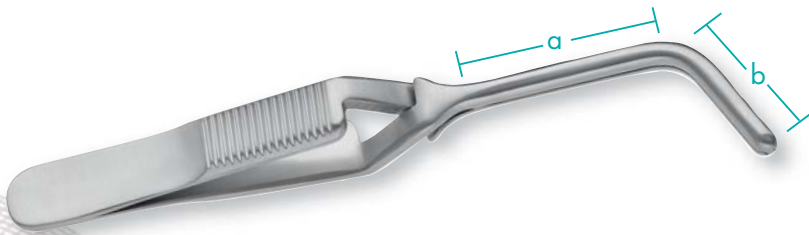

De Bakey Gregory Soft

Material: Stainless steel

Delicate atraumatic serrations



Article-No.		Length a	Length b
140-014-090	angled	90mm	48mm
140-014-110	angled	110mm	55mm

Article-No.		Length a	Length b
140-015-090	straight	90mm	48mm
140-015-110	straight	110mm	55mm

Gregory Bulldog clamps

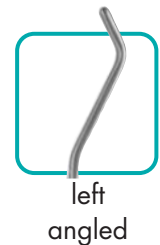
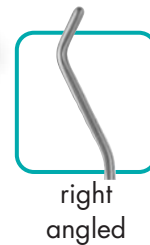

De Bakey Gregory

Material: Stainless steel

Delicate atraumatic serrations



140-014-025	left angled	110mm total length
140-114-025	right angled	110mm total length

Santulli Bulldog Clamps

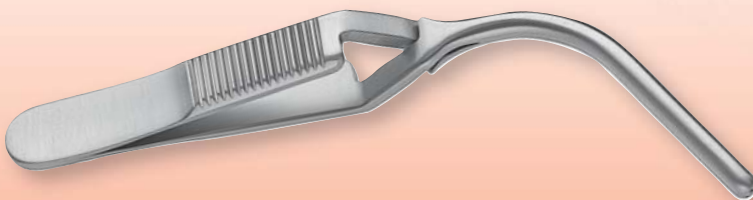

De Bakey Santulli

Material: Stainless steel

Delicate atraumatic serrations



140-135-070	curved	70mm total length
-------------	--------	-------------------

Glover Delicate Bulldog Clamps



straight



curved

De Bakey Glover Delicate

Material: Stainless steel

Extra delicate atraumatic serrations

Closing pressure adjustable



Article-No.		Total length	Jaw length
290-410-050	straight	50mm	20mm
290-411-050	curved	50mm	20mm
290-410-070	straight	70mm	30mm
290-410-085	straight	85mm	45mm
290-411-070	curved	65mm	30mm
290-411-085	curved	80mm	45mm

Potts (Jacobson) Bulldog Clamps

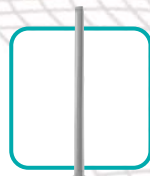

straight



curved



angled

Potts (Jacobson)

Material: Stainless steel

Very delicate serrations

Closing pressure adjustable



290-410-045	straight	45mm
290-411-045	curved	45mm
290-412-045	angled	45mm

Carotid Bulldog clamps

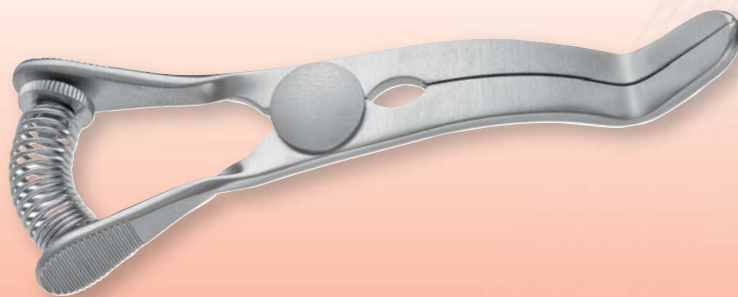

special curved

De Bakey Carotid

Material: Stainless steel

Delicate atraumatic serrations

Closing pressure adjustable



140-133-095	special curved	90mm
-------------	----------------	------

Featherlight Bulldog Clamps



Featherlight

Material: Stainless steel

Very delicate serrations

Closing pressure: 30gr.



straight



angled

Article-No.		Jaw length	Total length
140-310-030	straight	10mm	30mm
140-314-035	straight	14mm	35mm
140-318-040	straight	18mm	40mm
140-410-030	angled	10mm	30mm
140-414-035	angled	14mm	35mm
140-418-040	angled	18mm	40mm

Titanium Shunt Bulldog Clamps



Titanium Shunt

Material: Titanium

Smooth jaws without any serrations



10° angled



25° angled



45° angled



60° angled

Article-No.	Angle	Jaw Ø	Total length
290-795-010	10°	10 Fr	95mm
290-795-025	25°	10 Fr	95mm
290-795-045	45°	10 Fr	95mm
290-795-060	60°	10 Fr	95mm
290-795-210	10°	12 F	95mm
290-795-225	25°	12 Fr	95mm
290-795-245	45°	12 Fr	95mm
290-795-260	60°	12 Fr	95mm
290-795-410	10°	14 Fr	95mm
290-795-425	25°	14 Fr	95mm
290-795-445	45°	14 Fr	95mm
290-795-460	60°	14 Fr	95mm

De Bakey Atrauma Titanium Bulldog Clamps



straight



curved



45° angled

De Bakey Atrauma Titanium

Material: Titanium

Extra delicate atraumatic serrations



290-740-070	straight	70mm
290-740-080	straight	80mm
290-740-090	straight	90mm
290-740-100	straight	100mm
290-740-110	straight	110mm
290-740-120	straight	120mm
290-740-130	straight	130mm
290-743-070	curved	70mm
290-743-080	curved	80mm
290-743-090	curved	90mm
290-743-100	curved	100mm
290-743-110	curved	110mm
290-743-120	curved	120mm
290-743-130	curved	130mm
290-745-070	angled	70mm
290-745-080	angled	80mm
290-745-090	angled	90mm
290-745-100	angled	100mm
290-745-110	angled	110mm
290-745-120	angled	120mm
290-745-130	angled	130mm

TITANIUM

Diethrich Titanium Bulldog Clamps



De Bakey Diethrich

Material: Titanium

Extra delicate atraumatic serrations



290-760-010	straight	10mm jaw
290-760-014	straight	14mm jaw
290-760-020	straight	20mm jaw
290-761-010	angled	10mm jaw
290-761-014	angled	14mm jaw
290-761-020	angled	20mm jaw
290-762-010	curved	10mm jaw
290-762-014	curved	14mm jaw
290-762-020	curved	20mm jaw



straight



angled



curved

Diethrich

Material: Titanium

Extra delicate serrations



140-760-008	straight	8mm jaw
140-760-012	straight	12mm jaw
140-760-020	straight	20mm jaw
140-761-008	angled	8mm jaw
140-761-012	angled	12mm jaw
140-761-020	angled	20mm jaw
140-762-008	curved	8mm jaw
140-762-012	curved	12mm jaw
140-762-020	curved	20mm jaw

Wickham Bulldog Clamps



Wickham

Material: Stainless steel

Very delicate serrations

Closing pressure: 150gr. (+/- 10gr.)



straight



45° angled



curved

Article-No.		Jaw length	Total length
140-108-013	straight	13mm	49mm
140-108-018	straight	18mm	54mm
140-108-025	straight	25mm	61mm
140-109-013	angled	13mm	47mm
140-109-018	angled	18mm	51mm
140-109-025	angled	25mm	55mm
140-110-013	curved	13mm	48mm
140-110-018	curved	18mm	52mm
140-110-026	curved	25mm	59mm

Suitable
Applying
Forceps on
page 15

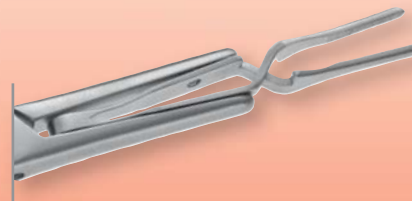

Applying forceps



For Mini Glover
Bulldog Clamps
(page 2 +3)

140-130-240	Mini Glover	240mm
-------------	-------------	-------

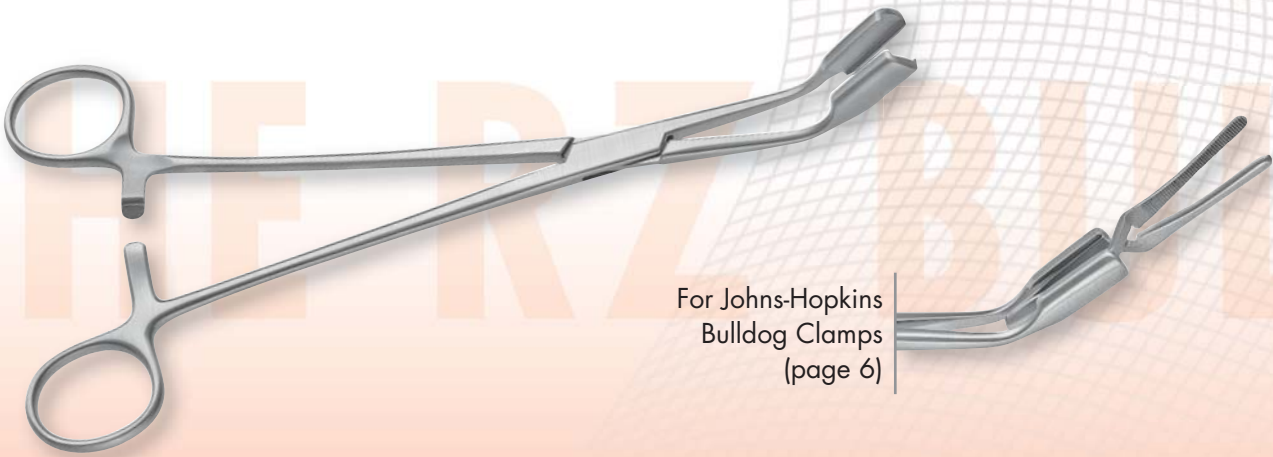

For Johns-Hopkins
Bulldog Clamps
(page 6)

140-152-230	Johns-Hopkins	230mm
-------------	---------------	-------



For De Bakey Atrauma
Bulldog Clamps
(page 4)

140-152-250	De Bakey Atrauma	250mm
-------------	------------------	-------



For Wickham
Bulldog Clamps
(page 13)

Rotatable Bulldogclamp
in Applying forceps

140-108-230	Wickham	230mm
-------------	---------	-------

Vascular Appliers and Clips



300-100-773 17mm jaws

300-100-774 25mm jaws

Endoscopic **Klein** Bulldog Clamp, straight, with atraumatic DeBakey serrations



300-100-771 45mm jaws

300-100-772 60mm jaws

Endoscopic **Klein** Bulldog Clamp, straight, with atraumatic DeBakey serrations



300-100-776 17mm jaws

300-100-777 25mm jaws

Endoscopic **Klein** Bulldog Clamp, curved, with atraumatic DeBakey serrations



300-100-778 45mm jaws

300-100-779 60mm jaws

Endoscopic **Klein** Bulldog Clamp, curved, with atraumatic DeBakey serrations

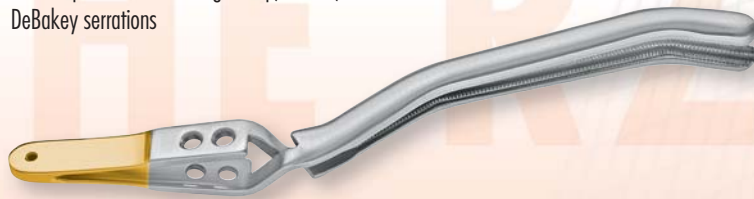

300-100-786 60mm jaws

Endoscopic **Klein** Satinsky Bulldog Clamp, with atraumatic DeBakey serrations, to be used with flexible Trocar System

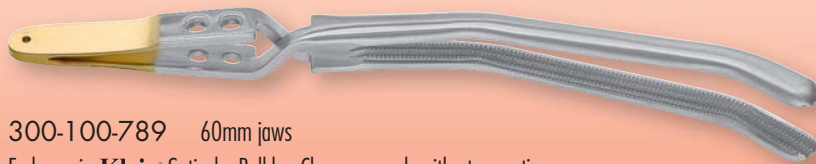

300-100-789 60mm jaws

Endoscopic **Klein** Satinsky Bulldog Clamp, curved, with atraumatic DeBakey serrations, to be used with flexible Trocar System

Endoscopic **Klein** Bulldog Clamps with DeBakey serrations advantages:

- Secure holding of occluded tissue structure
- Occlusion of vessel and other tissue without an additional part
- Atraumatic cross clamping of the colon



2x3 rows of teeth

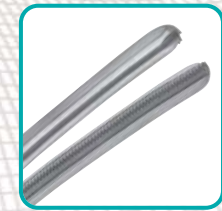
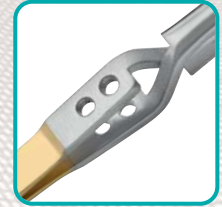

Endoscopic Appliers

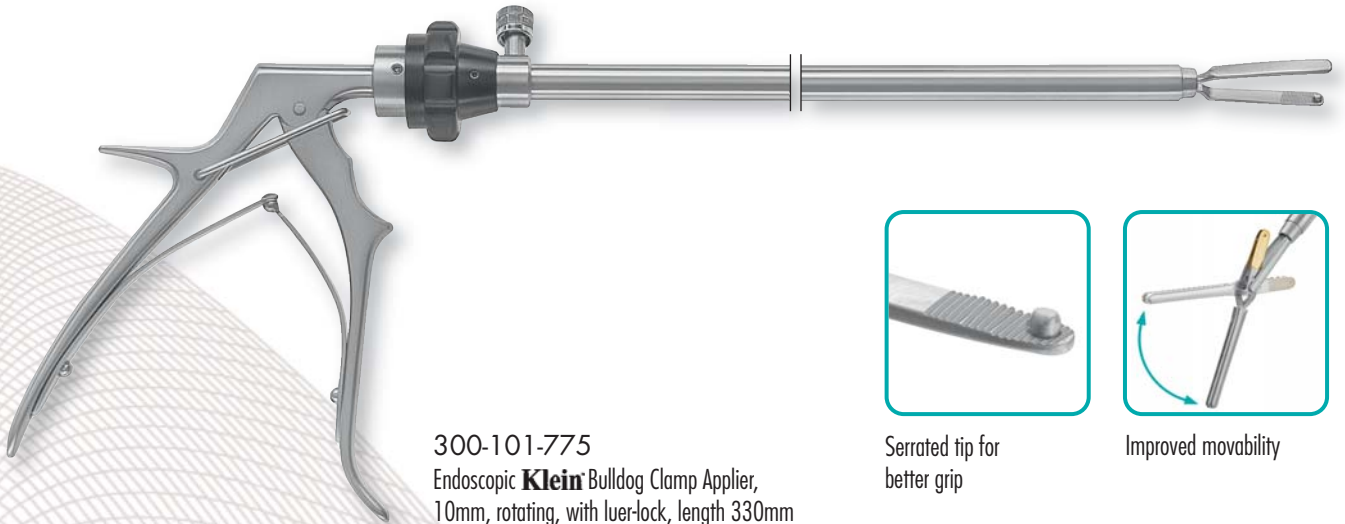

300-101-775
Endoscopic **Klein** Bulldog Clamp Applier,
10mm, rotating, with luer-lock, length 330mm



Serrated tip for
better grip



Improved movability



300-101-779
Stabilization tube to avoid rotating of the bulldogs in the jaw
of the Endoscopic Bulldog Clamp Applier, length: 300mm



300-410-775
Endoscopic Bulldog Clamp Applier,
detachable, 10mm, rotating, length: 330mm



300-401-775
Endoscopic Bulldog Clamp Applier, detachable (insert only)

Serrations

De Bakey

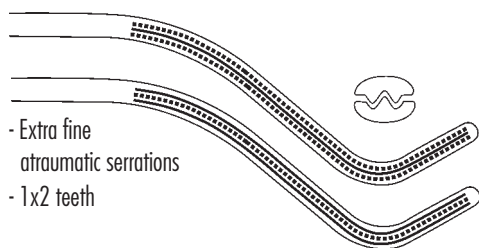

Cooley

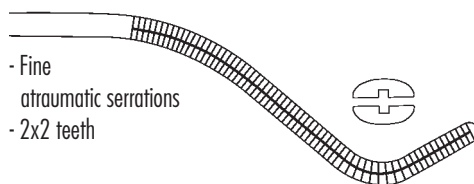

Horizontal Serrations

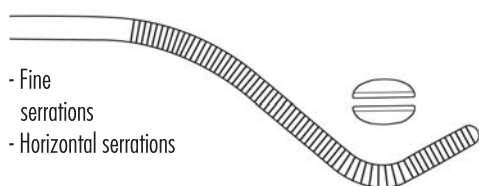

Smooth Jaws

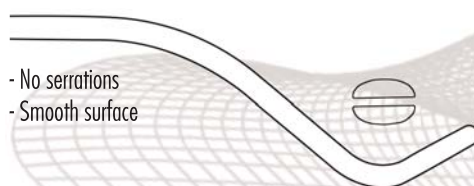

De Bakey (Endoscopic Klein Bulldog Clamps)

